



resine per pavimenti



URBAN STYLE

RESINE CONTEMPORANEE

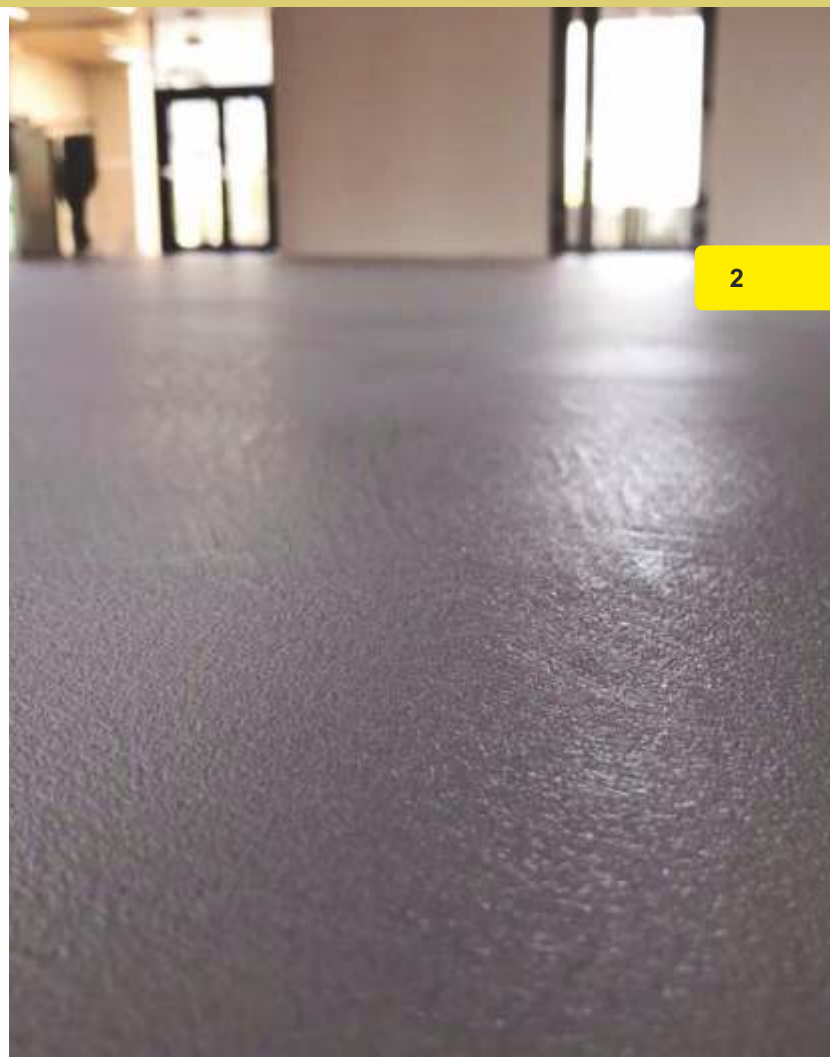



GP EPOXY

RESINA EPOSSIDICA A RULLO





POLIFLEX

POLIURETANICO SPATOLA / RULLO





GP EPOXY COLOR

AUTOLIVELLANTE A SPATOLA



COLORI

Attenzione il riferimento originale del colore consultare la cartella colori RAL

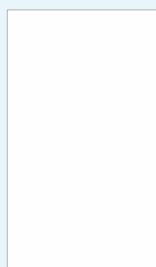

Bianco

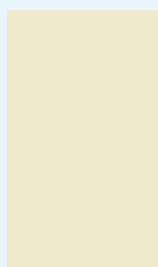

Ral 1013

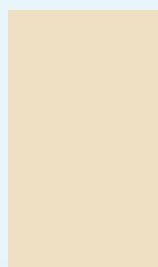

Ral 1015

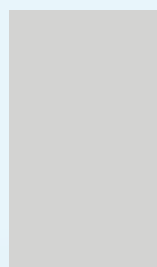

Ral 7047



Ral 7044

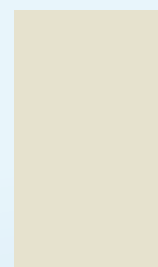

Ral 9002



Ral 7042



Ral 1005



Ral 5012



Ral 5015



Ral 6002



Ral 3011



Ral 3002



Ral 6019



CARTELLA COLORI RIFERIMENTO RAL



GP EPOXY *PAVIMENTAZIONI MONOCROMATICI*



CENTRO LIDL *100% EPOXY APPLICATO A RULLO*



GP EPOXY

RESINA EPOSSIDICA A RULLO



12

8



GP EPOXY

RESINA EPOSSIDICA A RULLO





GP EPOXY A RULLO

RESINA EPOSSIDICA A RULLO





POLIURETANICO J-34 *POLIFLEX 2K A RULLO*





GP EPOXY MASTER

RESINA EPOSSIDICA A SPATOLA



1



Applicare uno strato di **PRIMER J-40/P5 FILLER** applicazione a rullo. il prodotto deve essiccare 24h prima di procedere con le rasature.

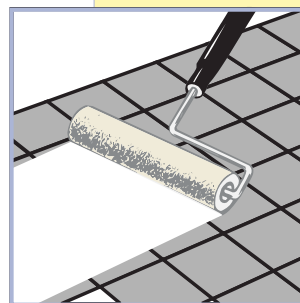

2

3

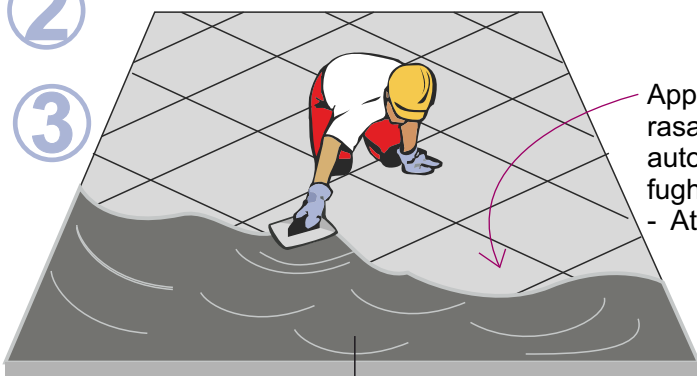

Applicare n.2 strati di rasatura epossidica o autolivellante, si coprono fughe e buche.
- Attesa: 12 ore per strato



RASATURA EPOSSIDICA A SPATOLA GP TRIO 3K



13

4

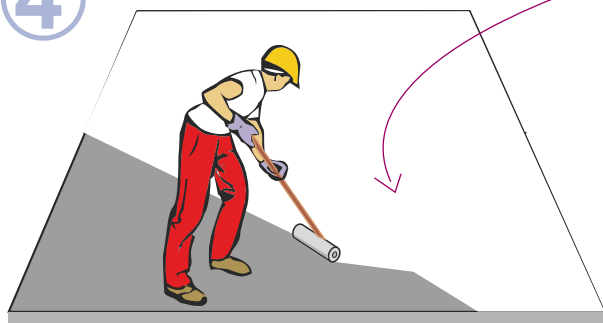

Finitura:
Procedere applicando **1 o 2 strati di GARAGE PAINT**, con uno stacco di 12 ore tra i cicli

Il pavimento è usabile dopo 10/15 giorni di stagionatura.

CONSUMI:

- **Autolivellante J-39-C** - Consumo medio al m² Kg. 1 per millimetro di spessore
- **Rasatura GP TRIO B1 J-32-GM** - Consumo medio al m² gr. 300/400 per strato granulometria inerte 0,06-0,1



RASATURA EPOSSIDICA A SPATOLA **GP TRIO 3K**





RASATURA EPOSSIDICA A SPATOLA **GP EPOXY MASTER**





RASATURA EPOSSIDICA A SPATOLA **GP EPOXY MASTER**





RASATURA EPOSSIDICA A SPATOLA **GP EPOXY MASTER**



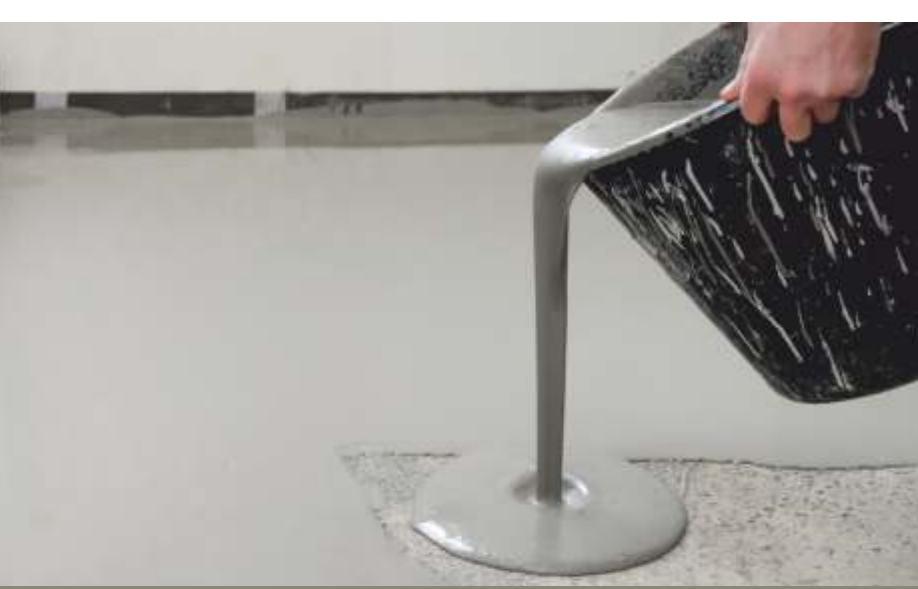

RASATURA EPOSSIDICA A SPATOLA GP EPOXY MASTER



18





RASATURA EPOSSIDICA A SPATOLA GP EPOXY MASTER



19





Vmicrocemento
eneziano
IL PAVIMENTO D'AUTORE



**MICROCEMENTO
VENEZIANO**



Vmicrocemento
eneziano
IL PAVIMENTO D'AUTORE



**MICROCEMENTO
VENEZIANO**



V microcemento
eneziano
IL PAVIMENTO D'AUTORE



MICROCEMENTO
VENEZIANO



V microcemento
Veneziano
IL PAVIMENTO D'AUTORE



MICROCEMENTO
VENEZIANO

V microcimento
eneziano
IL PAVIMENTO D'AUTORE



MICROCEMENTO
VENEZIANO

24

J-49M MICRO VENEZIANO
medio applicato a spatola



Vmicrocemento
eneziano
IL PAVIMENTO D'AUTORE



PAVIMENTI D'AUTORE *APPLICATO A SPATOLA*

V microcemento
eneziano
IL PAVIMENTO D'AUTORE



MICROCEMENTO VENEZIANO

COLORI

Microstucco Veneziano è disponibile in
colorazioni materiche

26



V microcemento
eneziano
IL PAVIMENTO D'AUTORE



**MICROCEMENTO
VENEZIANO**





resine per pavimenti

www.resineitalia.it - www.jumbopaint.it



monzo paint® 

84047 Capaccio Paestum (Sa) Tel.0828.723315
www.jumbopaint.it